

THE PROPERTY OF THE DRAWING IS ESTABLISHED BY LAW. IT IS FORBIDDEN TO PRODUCE OR SHOW IT TO THIRD PARTY, WITHOUT A WRITTEN AGREEMENT.

Item	Name	Q.ty
1	CA.GWP.5.60	2
2	R.5.SCH	8
3	SVB.X.50.50	1
4	V.TCE5x12	8

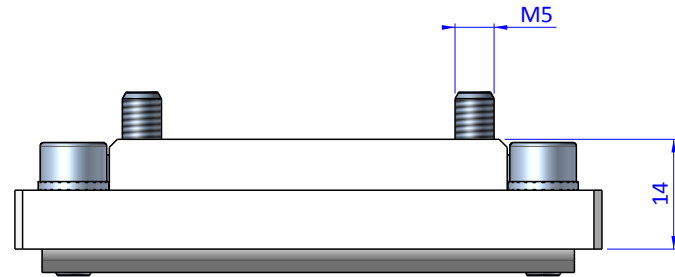
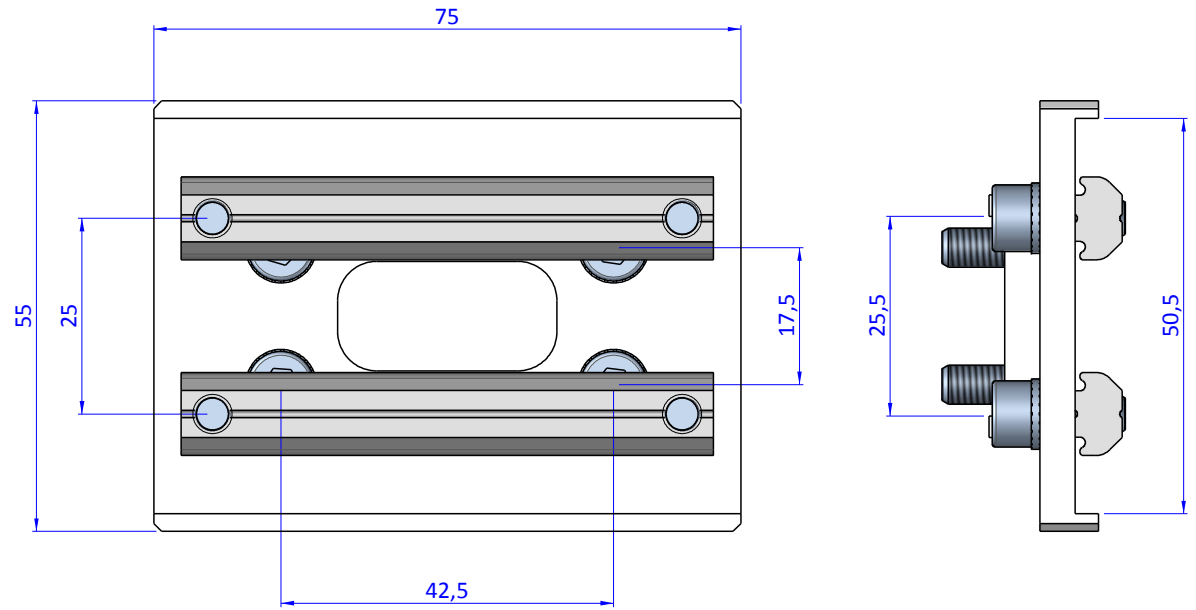
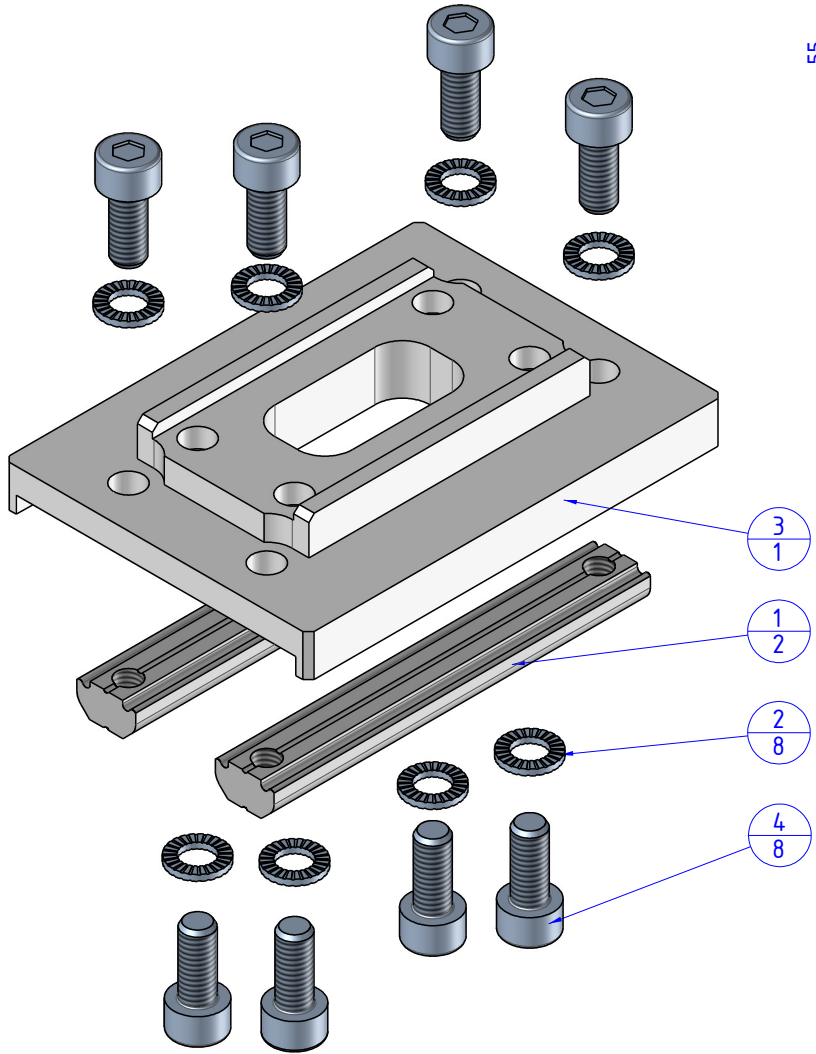

Format A3

UNI 936-76

		DESIGNED FROM	REVIEW
		FP SERVICES	A
GENERAL TOLERANCE	DESCRIPTION	DATE	WEIGHT
UNI - ISO 2768	CA.SVB.X.50.50	30/04/2016	0,149kg
CLASSE f		CODE	CA.SVB.X.50.50